



PROGRAM STUDI TEKNIK SIPIL  
FAKULTAS TEKNIK  
UNIVERSITAS GALUH

JUDUL GAMBAR

CROSS STA 0+100

KETERANGAN

SKALA 1:100

DOSEN PEMBIMBING

Ir. Uu Saepudin, S.T., M.T.  
NIK. 3112770116

Ir. Yanti Defiana, S.T., M.T.  
NIK. 3112770447

MAHASISWA

Luthfi Nurul Hakim  
NIM. 7011210069

0+100.00

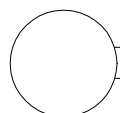
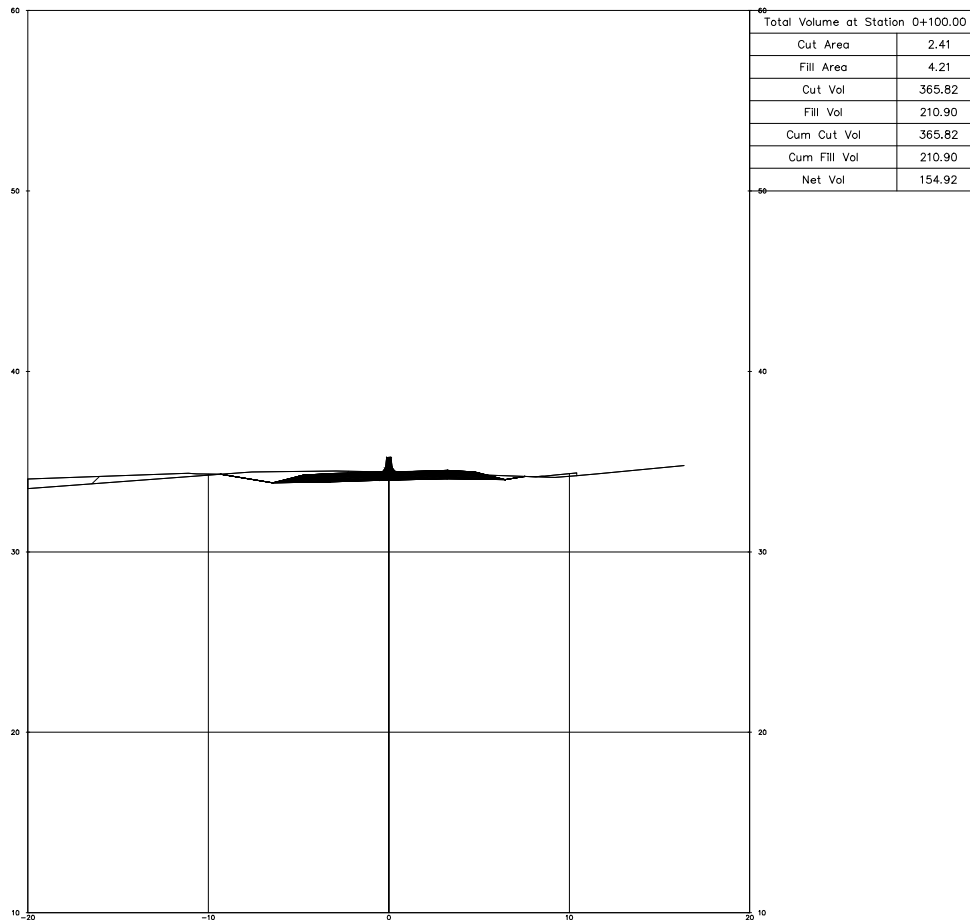

CROSS STA 0+100

SKALA 1:100



PROGRAM STUDI TEKNIK SIPIL  
 FAKULTAS TEKNIK  
 UNIVERSITAS GALUH

JUDUL GAMBAR

CROSS STA 0+200

KETERANGAN

SKALA 1:100

DOSEN PEMBIMBING

Ir. Uu Saepudin, S.T., M.T.  
 NIK. 3112770116

Ir. Yanti Defiana, S.T., M.T.  
 NIK. 3112770447

MAHASISWA

Luthfi Nurul Hakim  
 NIM. 7011210069

0+200.00

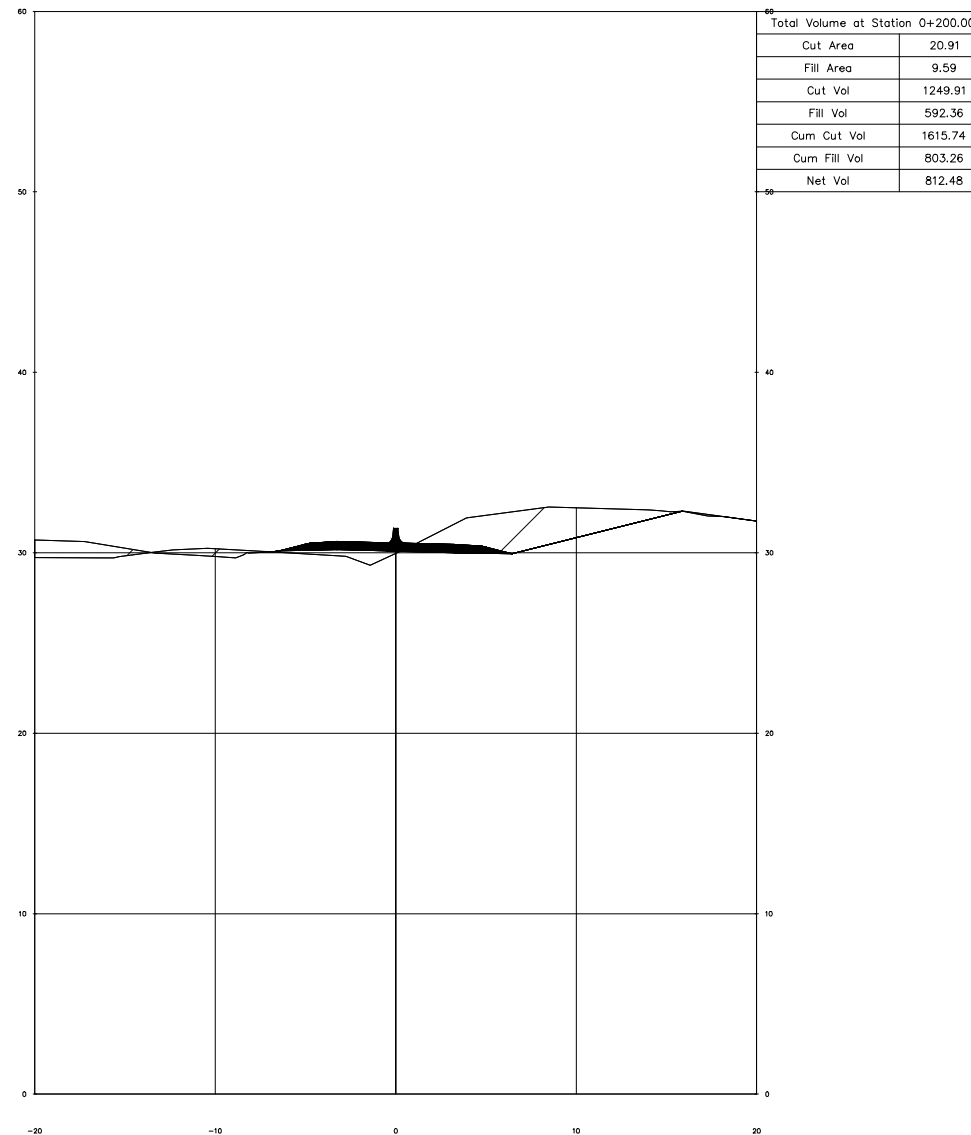

CROSS STA 0+200  
 SKALA 1:100



PROGRAM STUDI TEKNIK SIPIL  
FAKULTAS TEKNIK  
UNIVERSITAS GALUH

JUDUL GAMBAR

CROSS STA 0+300

KETERANGAN

SKALA 1:100

DOSEN PEMBIMBING

Ir. Uu Saepudin, S.T., M.T.  
NIK. 3112770116

Ir. Yanti Defiana, S.T., M.T.  
NIK. 3112770447

MAHASISWA

Luthfi Nurul Hakim  
NIM. 7011210069

0+300.00

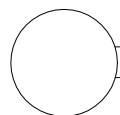
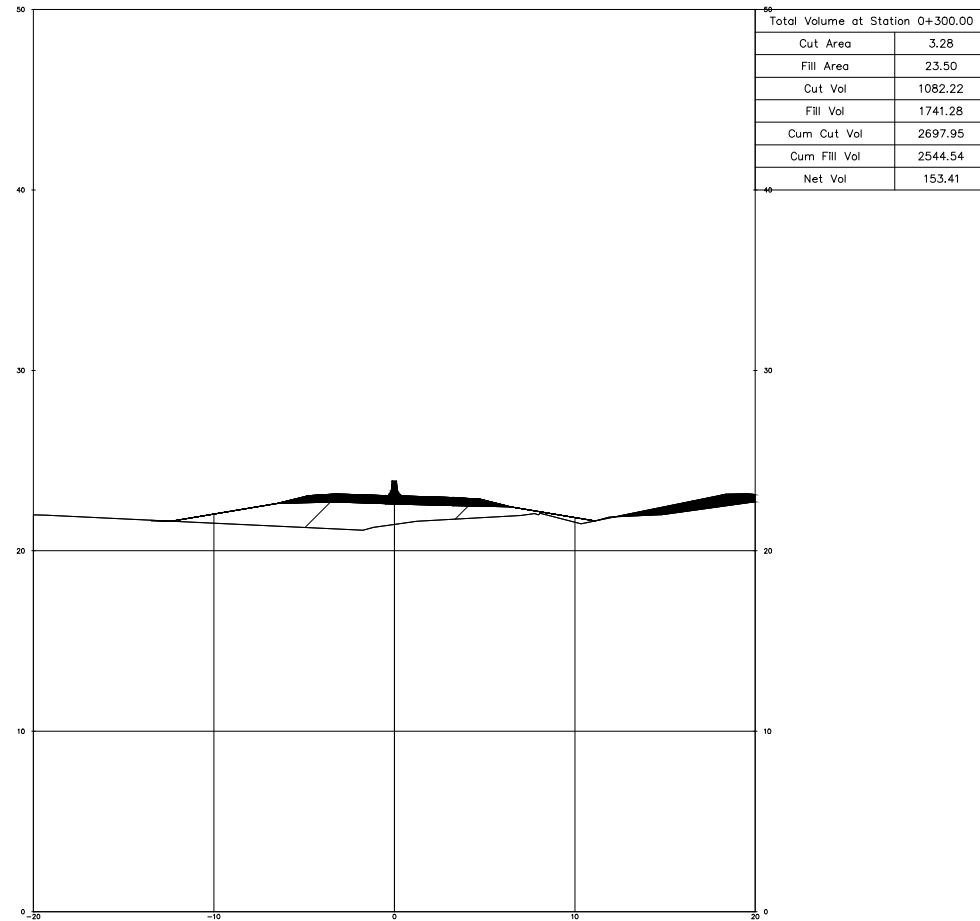

CROSS STA 0+300

SKALA 1:100



PROGRAM STUDI TEKNIK SIPIL  
FAKULTAS TEKNIK  
UNIVERSITAS GALUH

JUDUL GAMBAR

CROSS STA 0+723.39

KETERANGAN

SKALA 1:100

DOSEN PEMBIMBING

Ir. Uu Saepudin, S.T., M.T.  
NIK. 3112770116

Ir. Yanti Defiana, S.T., M.T.  
NIK. 3112770447

MAHASISWA

Luthfi Nurul Hakim  
NIM. 7011210069

0+713.39

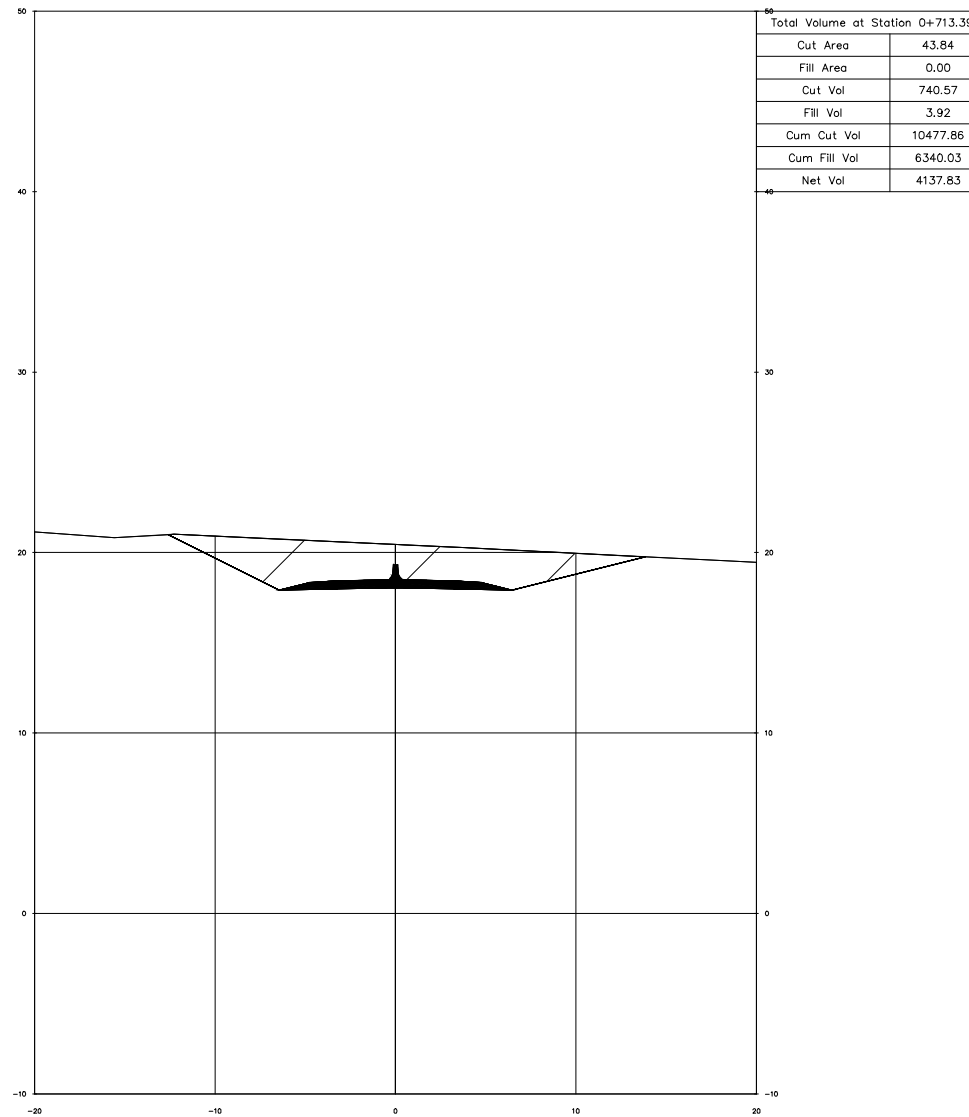

CROSS STA 0+723.39  
SKALA 1:100



PROGRAM STUDI TEKNIK SIPIL  
FAKULTAS TEKNIK  
UNIVERSITAS GALUH

JUDUL GAMBAR

CROSS STA 0+700

KETERANGAN

SKALA 1:100

DOSEN PEMBIMBING

Ir. Uu Saepudin, S.T., M.T.  
NIK. 3112770116

Ir. Yanti Defiana, S.T., M.T.  
NIK. 3112770447

MAHASISWA

Luthfi Nurul Hakim  
NIM. 7011210069

0+700.00

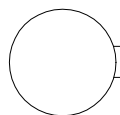
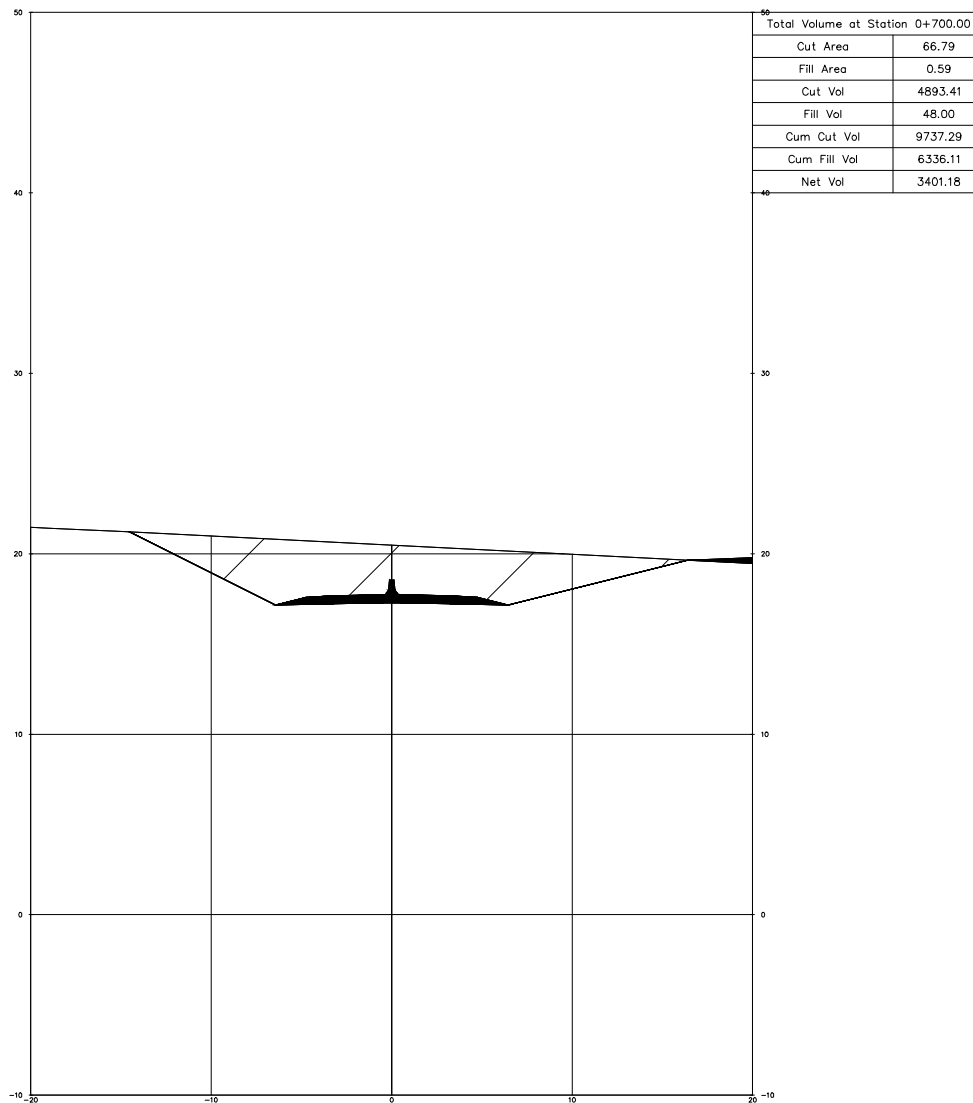

CROSS STA 0+700

SKALA 1:100



PROGRAM STUDI TEKNIK SIPIL  
FAKULTAS TEKNIK  
UNIVERSITAS GALUH

JUDUL GAMBAR

CROSS STA 0+600

KETERANGAN

SKALA 1:100

DOSEN PEMBIMBING

Ir. Uu Saepudin, S.T., M.T.  
NIK. 3112770116

Ir. Yanti Defiana, S.T., M.T.  
NIK. 3112770447

MAHASISWA

Luthfi Nurul Hakim  
NIM. 7011210069

0+600.00

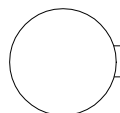
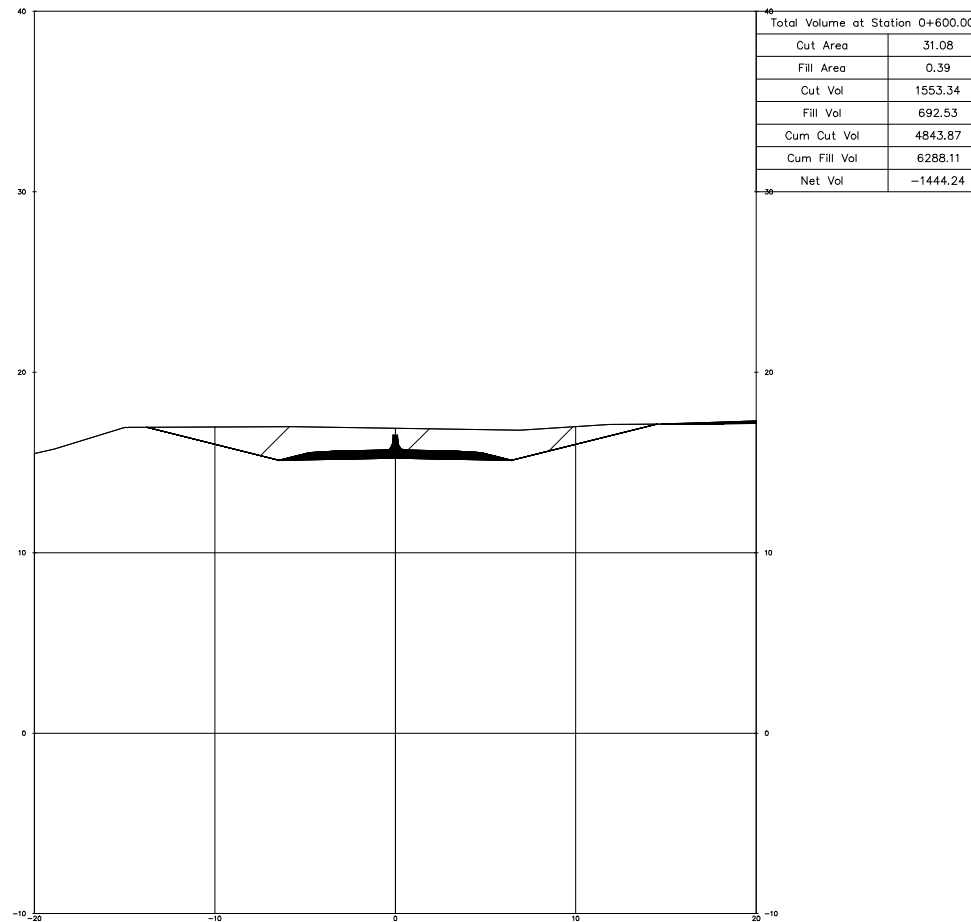

CROSS STA 0+600

SKALA 1:100



PROGRAM STUDI TEKNIK SIPIL  
FAKULTAS TEKNIK  
UNIVERSITAS GALUH

JUDUL GAMBAR

CROSS STA 0+500

KETERANGAN

SKALA 1:100

DOSEN PEMBIMBING

Ir. Uu Saepudin, S.T., M.T.  
NIK. 3112770116

Ir. Yanti Defiana, S.T., M.T.  
NIK. 3112770447

MAHASISWA

Luthfi Nurul Hakim  
NIM. 7011210069

0+500.00

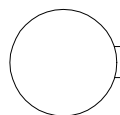
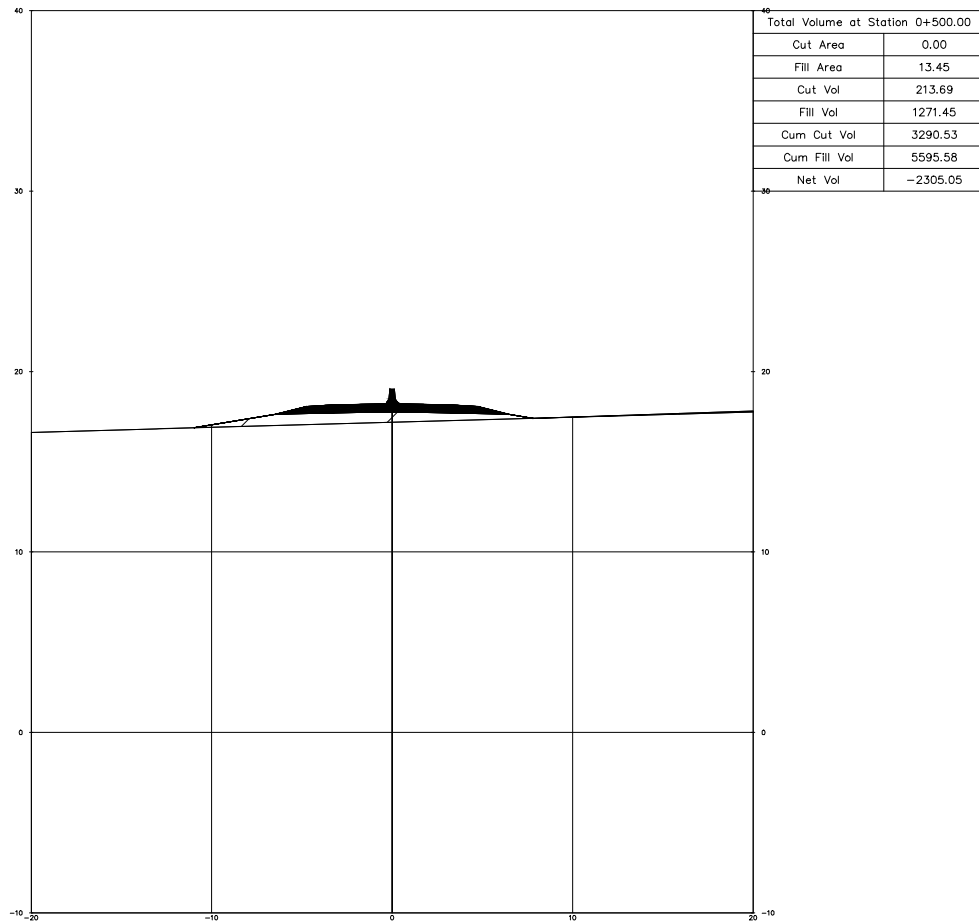

CROSS STA 0+500

SKALA 1:100



PROGRAM STUDI TEKNIK SIPIL  
FAKULTAS TEKNIK  
UNIVERSITAS GALUH

JUDUL GAMBAR

CROSS STA 0+400

KETERANGAN

SKALA 1:100

DOSEN PEMBIMBING

Ir. Uu Saepudin, S.T., M.T.  
NIK. 3112770116

Ir. Yanti Defiana, S.T., M.T.  
NIK. 3112770447

MAHASISWA

Luthfi Nurul Hakim  
NIM. 7011210069

0+400.00

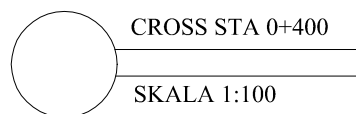
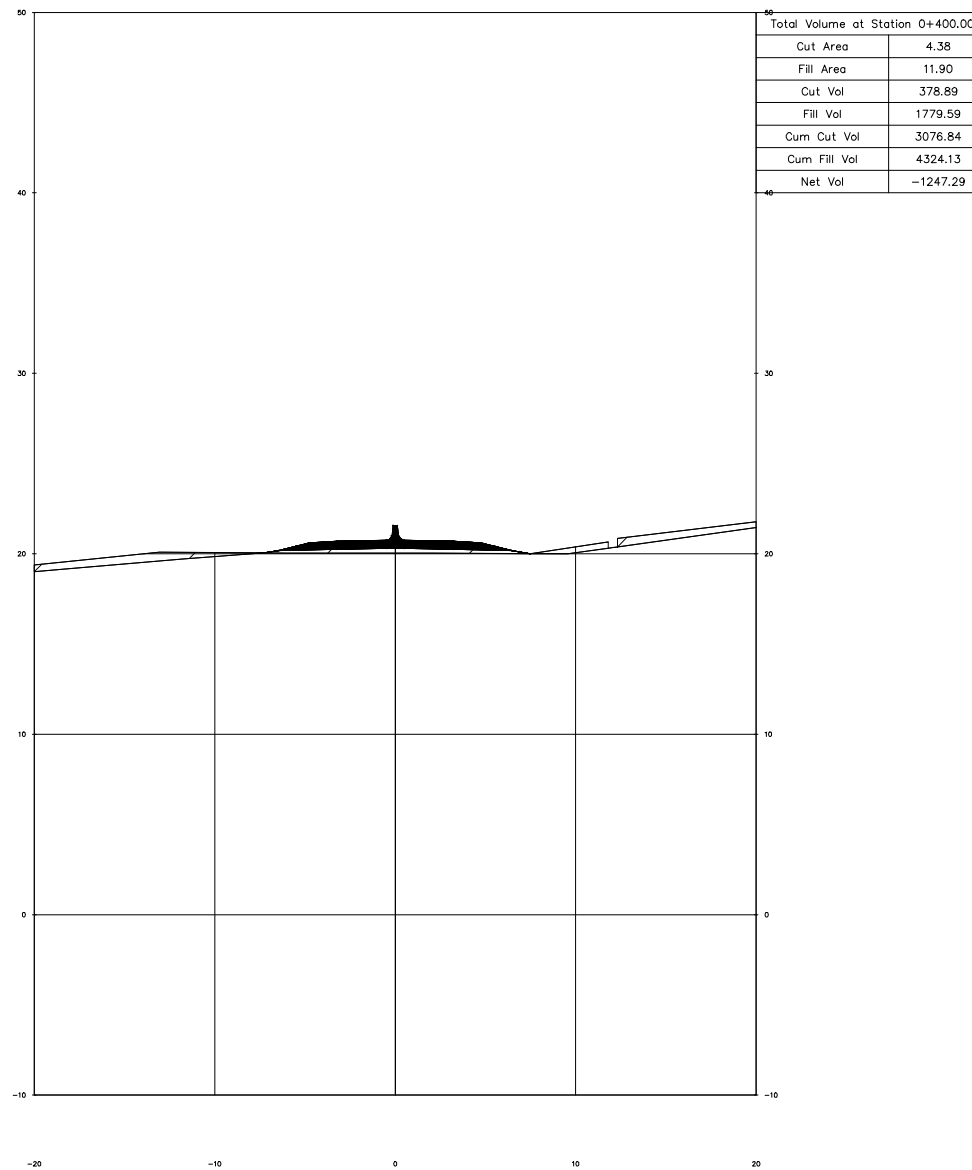



PROGRAM STUDI TEKNIK SIPIL  
FAKULTAS TEKNIK  
UNIVERSITAS GALUH

JUDUL GAMBAR

CROSS STA 0+000

KETERANGAN

SKALA 1:100

DOSEN PEMBIMBING

Ir. Uu Saepudin, S.T., M.T.  
NIK. 3112770116

Ir. Yanti Defiana, S.T., M.T.  
NIK. 3112770447

MAHASISWA

Luthfi Nurul Hakim  
NIM. 7011210069

0+000.00

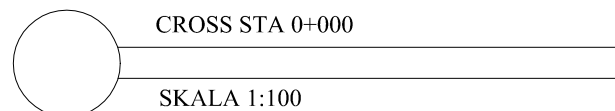
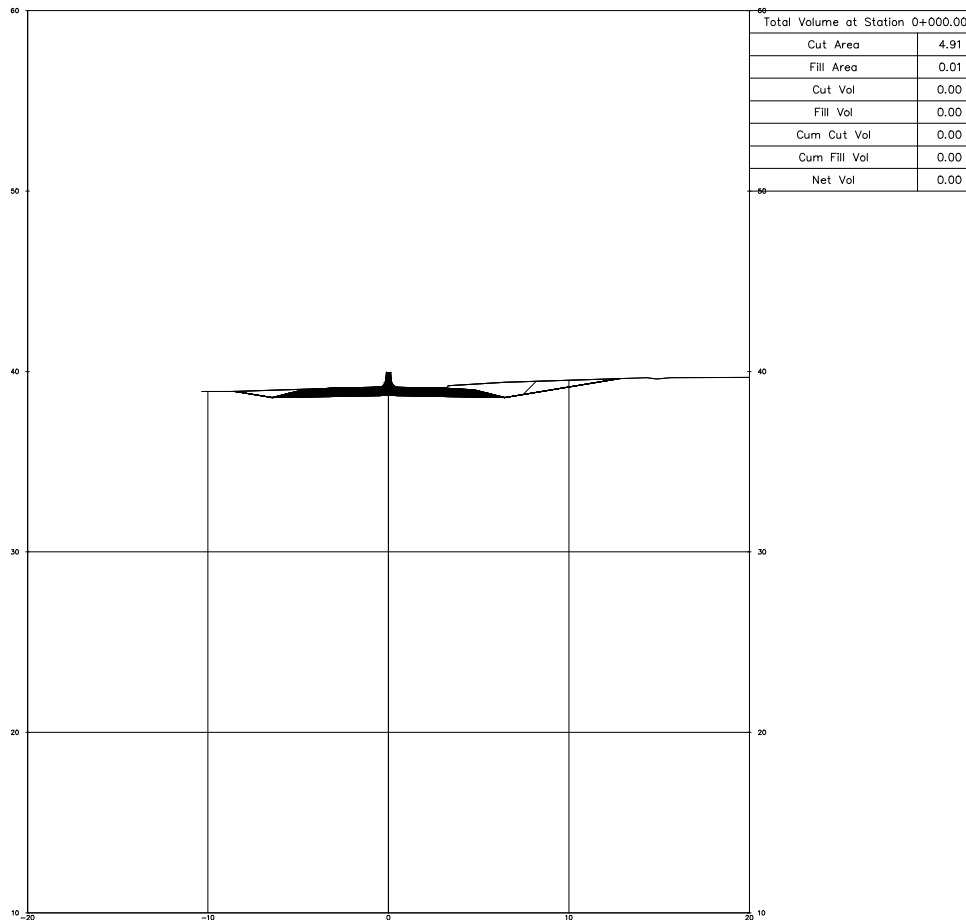

# DETAIL TIKUNGAN 4 (SS)

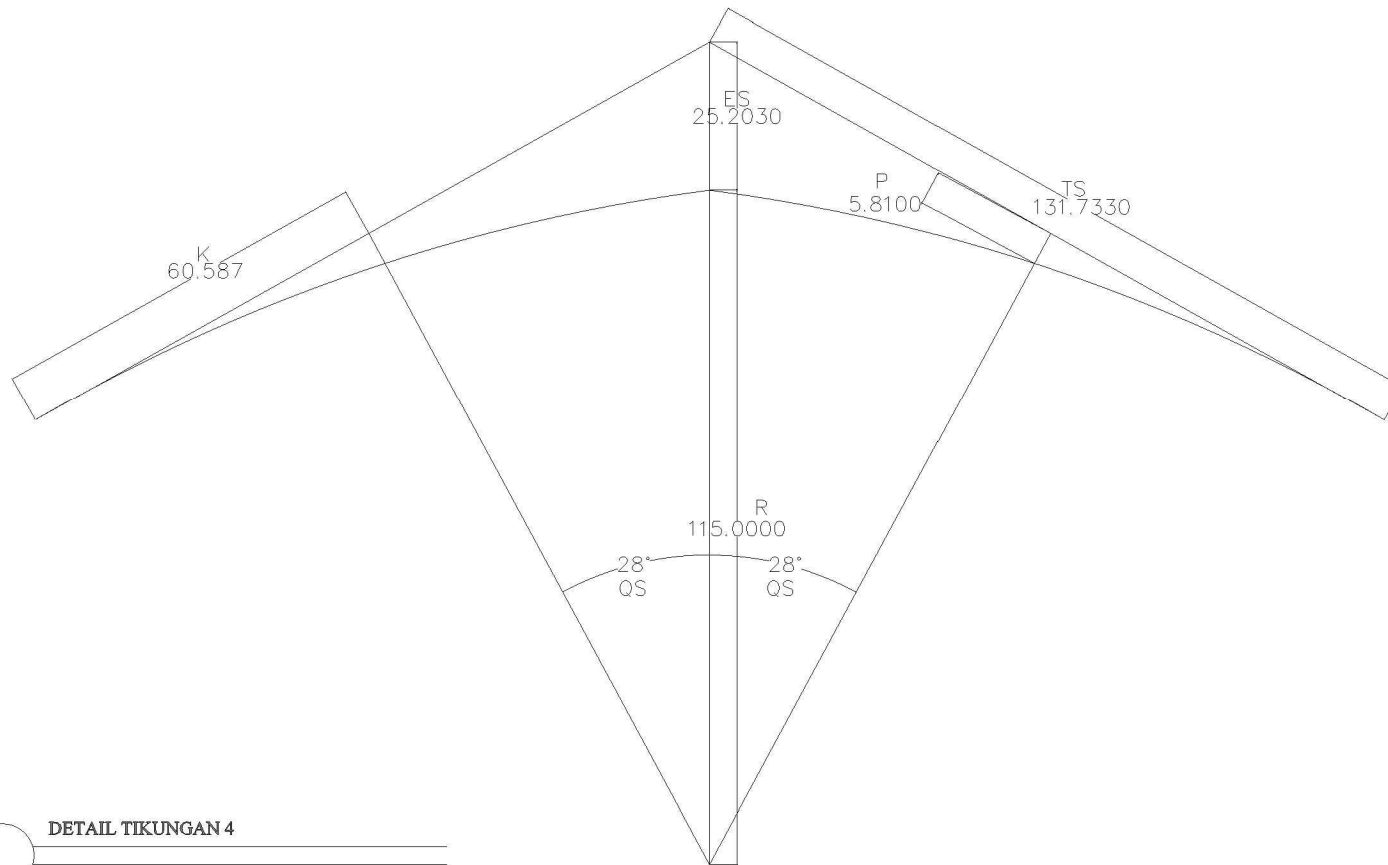

DETAIL TIKUNGAN 4  
SKALA 1:1000



PROGRAM STUDI TEKNIK SIPIL  
FAKULTAS TEKNIK  
UNIVERSITAS GALUH

JUDUL GAMBAR

DETAIL TIKUNGAN 4

KETERANGAN

SKALA 1:1000

DOSEN PEMBIMBING

Ir. Uu Saepudin, S.T., M.T.  
NIK. 3112770116

Ir. Yanti Defiana, S.T., M.T.  
NIK. 3112770447

MAHASISWA

Luthfi Nurul Hakim  
NIM. 7011210069

# DETAIL TIKUNGAN 3 (SS)

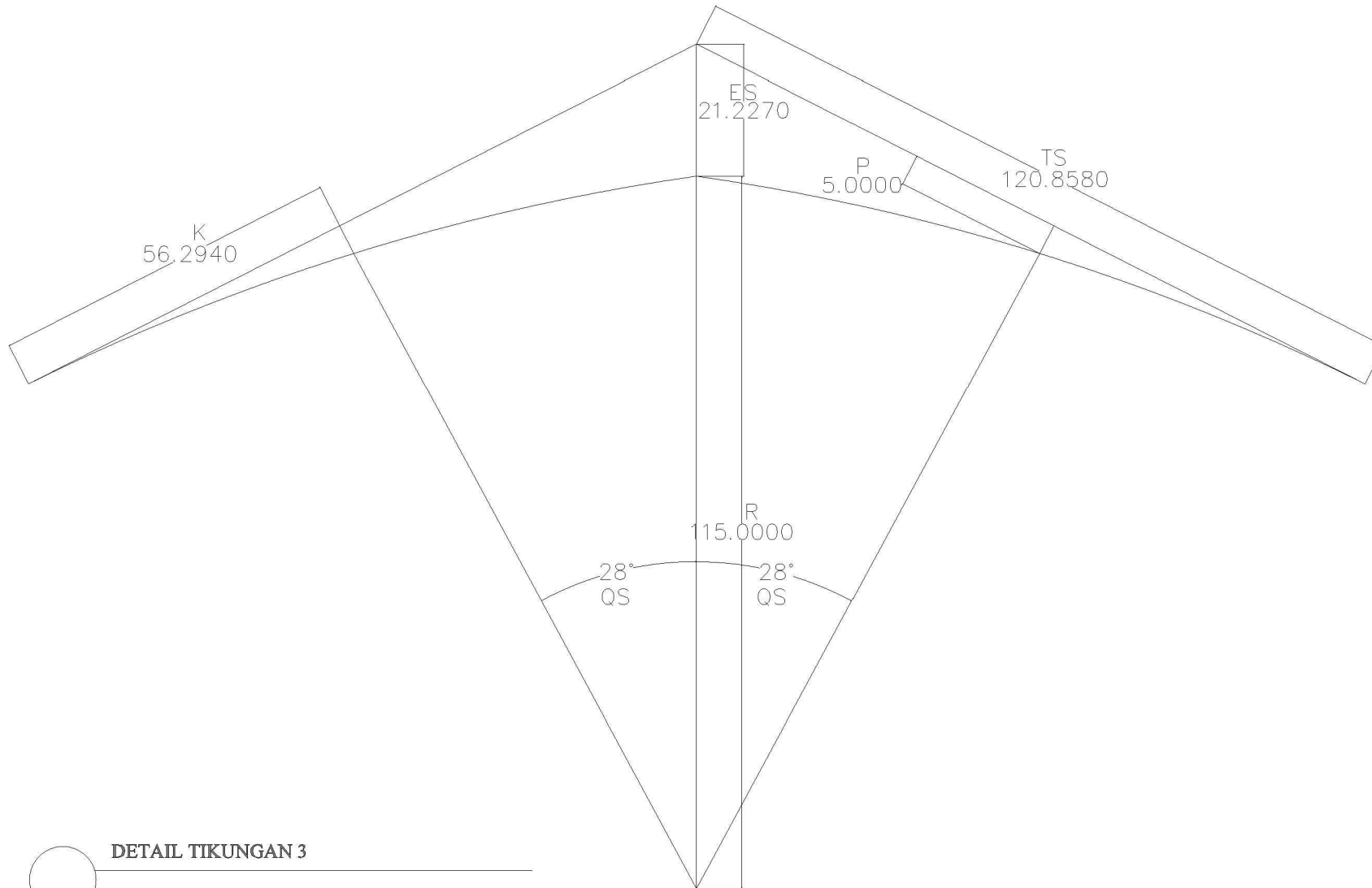

DETAIL TIKUNGAN 3  
SKALA 1:1000



PROGRAM STUDI TEKNIK SIPIL  
FAKULTAS TEKNIK  
UNIVERSITAS GALUH

JUDUL GAMBAR

DETAIL TIKUNGAN 3

KETERANGAN

SKALA 1:1000

DOSEN PEMBIMBING

Ir. Uu Saepudin, S.T., M.T.  
NIK. 3112770116

Ir. Yanti Defiana, S.T., M.T.  
NIK. 3112770447

MAHASISWA

Luthfi Nurul Hakim  
NIM. 7011210069

# DETAIL TIKUNGAN 2 (SCS)

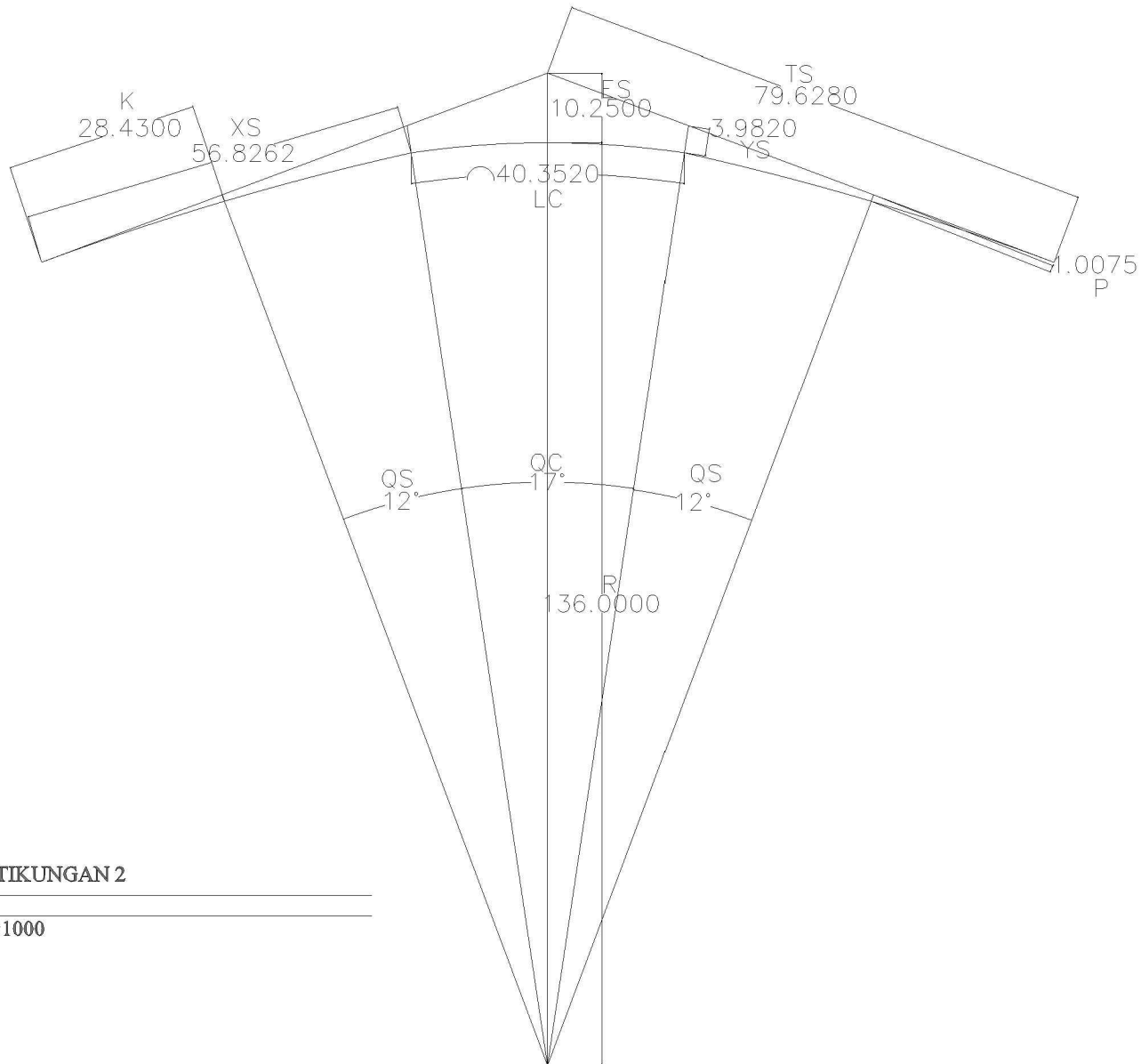

○ **DETAIL TIKUNGAN 2**  
 SKALA 1:1000



PROGRAM STUDI TEKNIK SIPIL  
 FAKULTAS TEKNIK  
 UNIVERSITAS GALUH

JUDUL GAMBAR

DETAIL TIKUNGAN 2

KETERANGAN

SKALA 1:1000

DOSEN PEMBIMBING

Ir. Uu Saepudin, S.T., M.T.  
 NIK. 3112770116

Ir. Yanti Defiana, S.T., M.T.  
 NIK. 3112770447

MAHASISWA

Luthfi Nurul Hakim  
 NIM. 7011210069

DETAIL TIKUNGAN 1 (SCS)

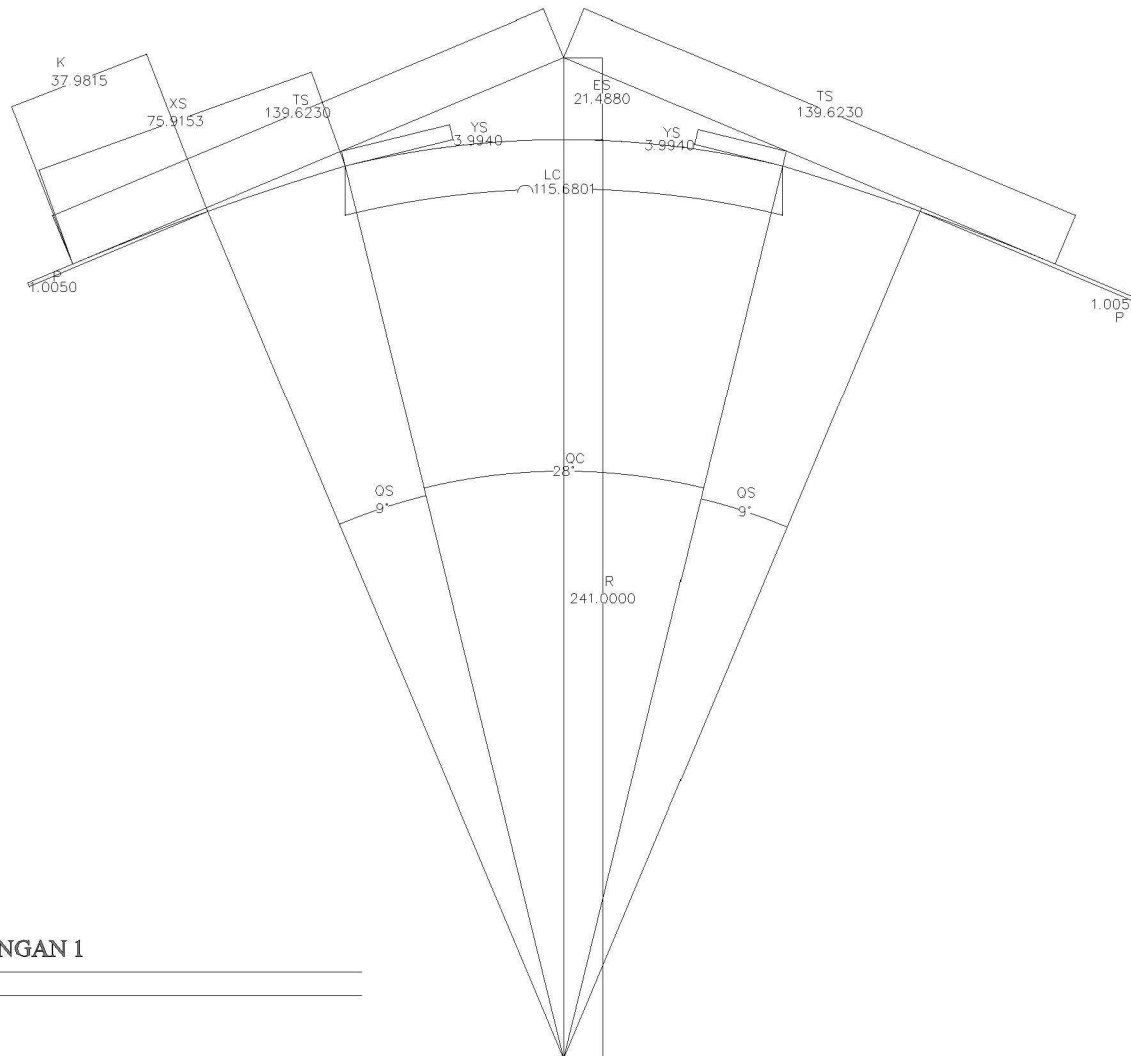

PROGRAM STUDI TEKNIK SIPIL  
FAKULTAS TEKNIK  
UNIVERSITAS GALUH

JUDUL GAMBAR

DETAIL TIKUNGAN 1

KETERANGAN

SKALA 1:1000

DOSEN PEMBIMBING

Ir. Uu Saepudin, S.T., M.T.  
NIK. 3112770116

Ir. Yanti Defiana, S.T., M.T.  
NIK. 3112770447

MAHASISWA

Luthfi Nurul Hakim  
NIM. 7011210069

DETAIL TIKUNGAN 1  
SKALA 1:1000



PROGRAM STUDI TEKNIK SIPIL  
FAKULTAS TEKNIK  
UNIVERSITAS GALUH

JUDUL GAMBAR

GALIAN DAN TIMBUNAN

KETERANGAN

SKALA 1:100

DOSEN PEMBIMBING

Ir. Uu Saepudin, S.T., M.T.  
NIK. 3112770116

Ir. Yanti Defiana, S.T., M.T.  
NIK. 3112770447

MAHASISWA

Luthfi Nurul Hakim  
NIM. 7011210069

Total Volume Table

Station	Fill Area	Cut Area	Fill Volume	Cut Volume	Cumulative Fill Vol	Cumulative Cut Vol
0+000.00	0.01	4.91	0.00	0.00	0.00	0.00
0+100.00	4.21	2.41	210.90	365.82	210.90	365.82
0+200.00	9.59	20.91	592.36	1249.91	803.26	1615.74
0+300.00	23.50	3.28	1741.28	1082.22	2544.54	2697.95
0+400.00	11.90	4.38	1779.59	378.89	4324.13	3076.84
0+500.00	13.45	0.00	1271.45	213.69	5595.58	3290.53
0+600.00	0.39	31.08	692.53	1553.34	6288.11	4843.87
0+700.00	0.59	66.79	48.00	4893.41	6336.11	9737.29
0+713.39	0.00	43.84	3.92	740.57	6340.03	10477.86

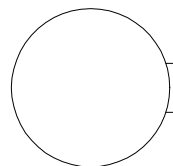

GALIAN DAN TIMBUNAN

SKALA 1:100



PROGRAM STUDI TEKNIK SIPIL  
FAKULTAS TEKNIK  
UNIVERSITAS GALUH

JUDUL GAMBAR

PENAMPANG MELINTANG

KETERANGAN

SKALA 1:1000

DOSEN PEMBIMBING

Ir. Uu Saepudin, S.T., M.T.  
NIK. 3112770116

Ir. Yanti Defiana, S.T., M.T.  
NIK. 3112770447

MAHASISWA

Luthfi Nurul Hakim  
NIM. 7011210069

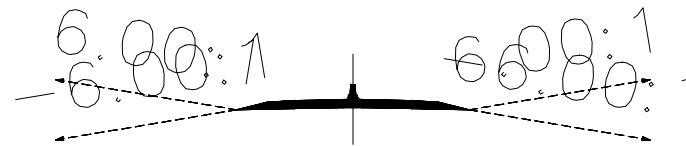



PROGRAM STUDI TEKNIK SIPIL  
 FAKULTAS TEKNIK  
 UNIVERSITAS GALUH

JUDUL GAMBAR

PROFILE ASLI

KETERANGAN

SKALA 1:100

DOSEN PEMBIMBING

Ir. Uu Saepudin, S.T., M.T.  
 NIK. 3112770116

Ir. Yanti Defiana, S.T., M.T.  
 NIK. 3112770447

MAHASISWA

Luthfi Nurul Hakim  
 NIM. 7011210069

Long section

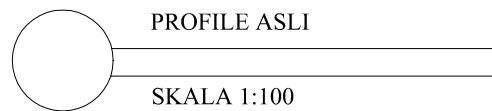
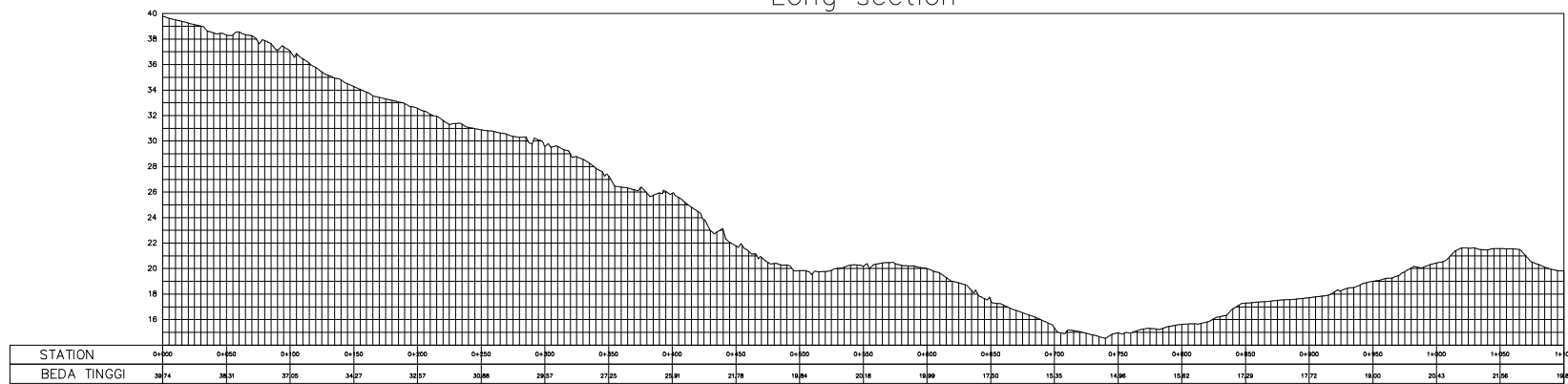



PROGRAM STUDI TEKNIK SIPIL  
FAKULTAS TEKNIK  
UNIVERSITAS GALUH

JUDUL GAMBAR

PROFILE REDESIGN

KETERANGAN

SKALA 1:250

DOSEN PEMBIMBING

Ir. Uu Saepudin, S.T., M.T.  
NIK. 3112770116

Ir. Yanti Defiana, S.T., M.T.  
NIK. 3112770447

MAHASISWA

Luthfi Nurul Hakim  
NIM. 7011210069

trase

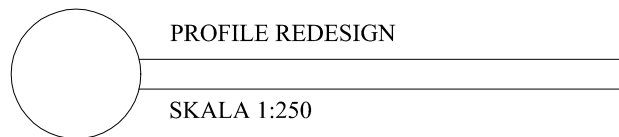
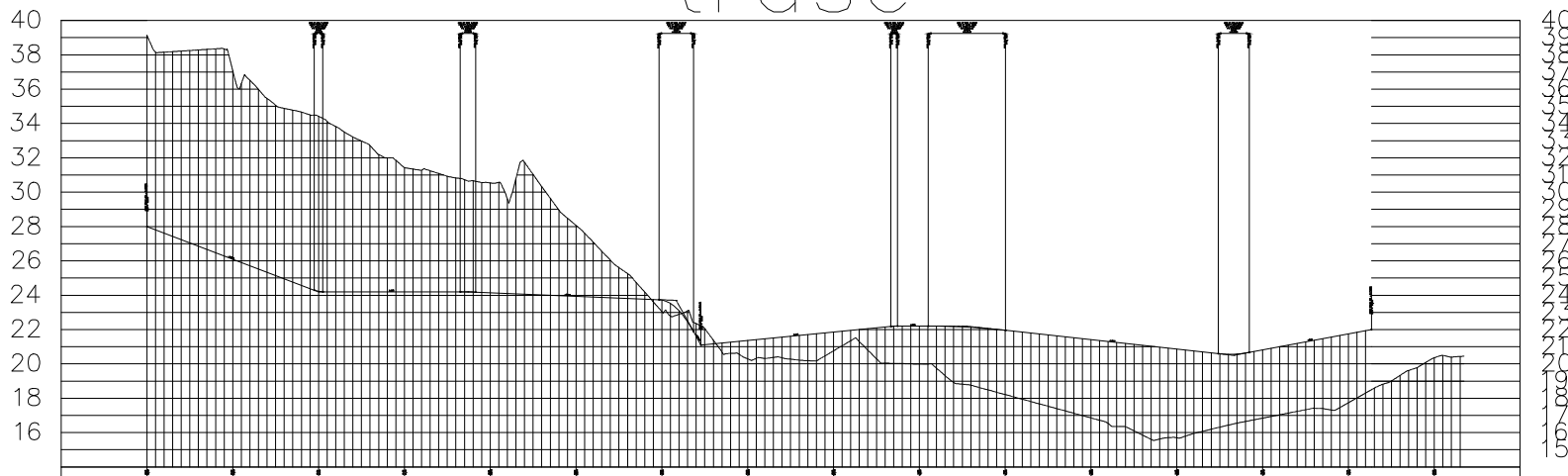



PROGRAM STUDI  
TEKNIK SIPIL  
FAKULTAS TEKNIK  
UNIVERSITAS GALUH

JUDUL GAMBAR

TRASE JALAN

KETERANGAN

SKALA  
1:100

DOSEN PEMBIMBING

Ir. Uu Saepudin, S.T., M.T.  
NIK. 3112770116

Ir. Yanti Defiana, S.T., M.T.  
NIK. 3112770447

MAHASISWA

Luthfi Nurul Hakim  
NIM. 7011210069

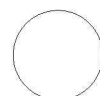
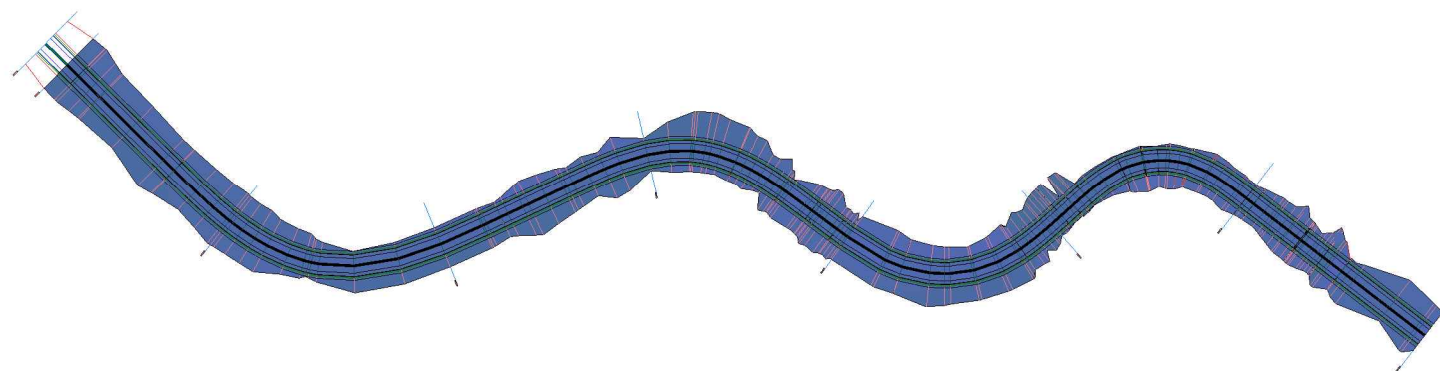

TRASE JALAN

SKALA 1:100



PROGRAM STUDI  
TEKNIK SIPIL  
FAKULTAS TEKNIK  
UNIVERSITAS GALUH

JUDUL GAMBAR

TOPOGRAFI DAN TRASE JALAN

KETERANGAN

SKALA  
1:100

DOSEN PEMBIMBING

Ir. Uu Saepudin, S.T., M.T.  
NIK. 3112770116

Ir. Yanti Defiana, S.T., M.T.  
NIK. 3112770447

MAHASISWA

Luthfi Nurul Hakim  
NIM. 7011210069

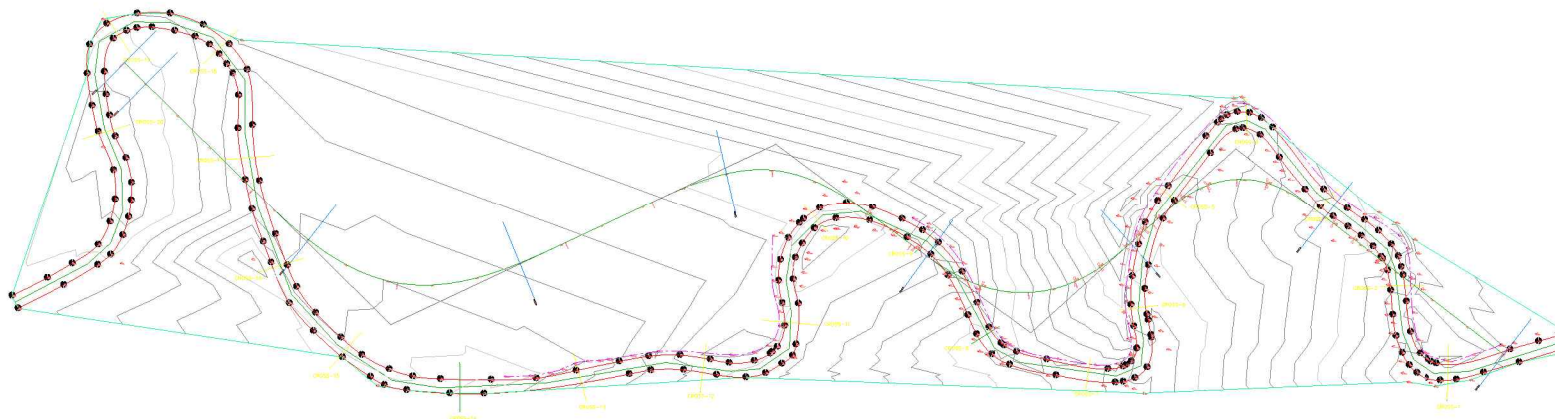

TOPOGRAFI DAN TRASE JALAN  
SKALA 1:100